

Edis

Instruction Manual



| Preface

Thank you for purchasing this digital video camera. Before use, please read this manual carefully. Keep this manual in a safe place for future reference.

The latest information at the time of compiling this manual is used for reference for the content of this manual. The screen displays, illustrations and other information adopted in this manual are to visually elaborate the operation of the video camera.

Depending on different technology development and production batches, it may be slightly different from the digital cameras you actually use.

Disclaimer notice: considerable effort has been made to ensure that this manual is free of inaccuracies and omissions. However, there is no guarantee that there will be no errors or omissions in this manual.

Contents

Getting Started

- 1. Check the camera and accessories 1
- 2. Battery installation and removal and battery charging
 - Installing / removing the battery 1
 - Battery charging 2
- 3. Memory card
 - Usable memory card 3
 - Recording time of the memory card (estimated) 3
 - Installation of memory card 4
- 4. Install the handle/ lens hood
 - Install the handle 4
 - Installing / removing the lens hood 5
- 5. Set date/time 5
- 6. Shoot
 - Shooting still images 6
 - Shooting video 6

Basic operation of this camera

- Camera button function introduction 7
- Remote Control 9
- Touch screen operation 9
- Using the menu button 10
- Using the mode button 10

Shooting function of this camera

- Shooting menu settings 10

Slowly mode / Lapse mode	11
Video pause.....	12
Auto focus	12
Mic interface.....	12
Fill light	13
Playback mode	13

Change camera settings

Memory card formatting.....	13
Auto shutdown setting.....	14
Reset.....	14

Operations with smartphones and computers

Use of WiFi	14
Use app to connect camera for shooting.....	15
Connect computer.....	16
Storage mode.....	16
PC cam mode.....	16
Connect HD TV	16
Charging mode	17

Usage notice

Safety Precautions.....	17
Camera cleaning and maintenance	18
Trouble removal.....	19



Getting Started

1. Check the camera and accessories

◎Standard list

Camera*1	Battery *1
Handle*1	Micro USB*1
Lens hood*1	Remote control*1
Manual *1	

2. Battery installation and removal and battery charging

◎Installing / removing the battery

Put the battery gently into the battery mounting slot, slide it to the up. It is installed in place until a click is heard.

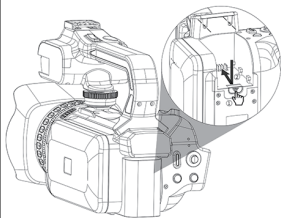

Push the battery lock switch and slide the battery down to remove it.

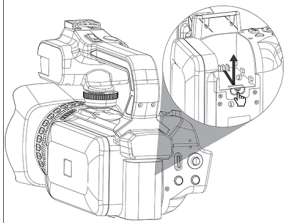

⊙ Battery charging

This camera uses high capacity rechargeable external lithium battery. Please put the battery into the battery slot correctly according to the battery and battery compartment slot.

(1) When charging with this camera, use USB line to connect the power adapter and the camera, and then connect the power supply to charge. When charging, the red light is always on, and the red light is off after fully charged.

Tips: The camera will turn on automatically when charging. The battery will be fully charged faster when charged in the off state.

(2) Battery charging time (estimated)

In the normal environment, it takes 4-5 hours to be fully charged.

(3) Continuous working hours (estimated)

When [system] is set to 4K and all other settings are factory default settings, it can work for 3-4 hours.

When [system] is set to 1080p and other resolutions, and all other settings are factory default settings, it can work for 4 hours.

⊙ Battery precautions

The battery is recommended to start charging in a temperature range of 10 °C to 30 °C. In a lower temperature, the battery may not be able to or need more time to be fully charged. When charging in a high temperature, it may shorten battery life.

The fully charged battery will naturally consume electricity. In order to ensure sufficient power, charging in advance is recommended.

When the camera is not used for a long time, please charge the battery every 3 months. Then let the battery discharge to maintain the battery life.



3.Memory card

⊙Usable memory card

This camera can use two types of memory cards, SDHC (Class10) and SDXC (Class10). Supports up to 256G.

⊙Recording time of the memory card (estimated)

The estimated recording time is just for reference and the specific time may be different depending on the memory card and battery condition.

RESOLUTION	16G	32G	64G	128G	256G
720P/30FPS	140	280	560	1120	2240
720P/60FPS	140	280	560	1120	2240
720P/120FPS	70	140	280	560	1120
1080P/30FPS	140	280	560	1120	2240
1080P/60FPS	70	140	280	560	1120
2.7K/30FPS	70	140	280	560	1120
4K/30FPS	70	140	280	560	1120
4K/60FPS	50	100	200	400	800

Note: if the memory card has already stored videos or photos not taken with this camera, its remaining recording time will be shortened.

Ⓢ Installation of memory card

Please insert the SD card into the card slot correctly.

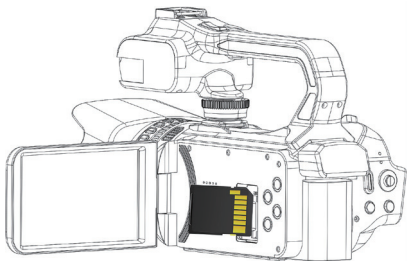

Inserting the wrong card may cause damage to the SD card and the card slot.

4. Install the handle/ lens hood

Ⓢ Install the handle

Slide the handle in the direction of the arrow, install it into the hot shoe holder of the camera, and then lock the handle button.

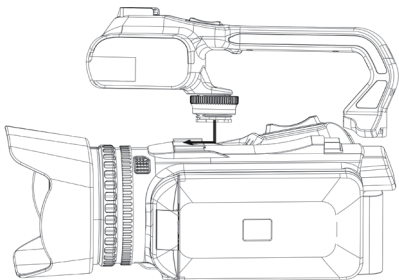



Ⓢ Installing / removing the lens hood

The lens hood can effectively reduce the diffused light that can cause lens halo and remake.

(1) Align the buckle marking lines ①② of the camera and the hood, and turn in the direction shown by the arrow until they are locked ①③.

(2) To remove the hood, turn it in the direction opposite to the direction of rotation during installation.

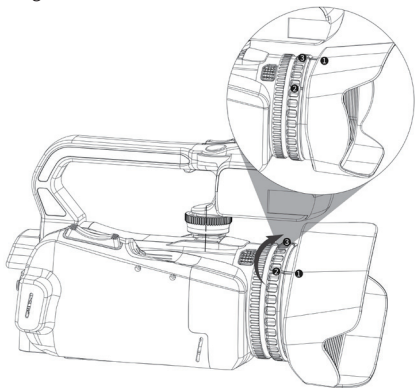

Note: Do not deform the hood.
Make sure that the lens hood is aligned with the camera marking line before turning.

5. Set date/time

(1) Turn on the camera

Open the LCD screen, and the camera will turn on automatically.

If the LCD screen has been opened, press power button and then the camera turn on.

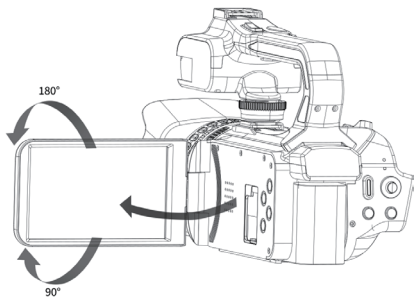

(2) After turning on, press the MENU button to enter the menu bar, and then press the MODE button to switch to the system setting menu.

(3) Then press the DOWN button to find the submenu-time format/time setting/date setting, and press the confirm button to enter the corresponding submenu.

(4) After the setting is completed, press the Mode button to exit the submenu setting.

Note: The built-in clock of this camera may have errors, please adjust the time regularly.

6. Shoot

⊙ Shooting still images

This section explains that in the normal camera mode, the situation is automatically recognized to determine the exposure, etc.

Press the camera button halfway to focus. When the focus frame on the display shows green, press the camera button fully.

⊙ Shooting video

This section explains that in the normal recording mode, the situation is automatically recognized to determine the exposure, etc.

Press the record button to start recording. Press the video button again to end the video.



Basic operation of this camera

Camera button function introduction

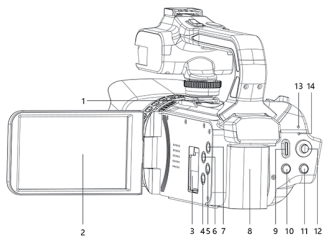

- 1: Camera hot shoe seat
- 2: LCD screen
- 3: SD card slot
- 4: Playback
- 5: Mode
- 6: Menu
- 7: Power
- 8: Battery slot
- 9: Shoot video button
- 10: Take photo button
- 11: DISP button
- 12: Confirm button / control dial
- 13: Charging indicator light
- 14: Working indicator light

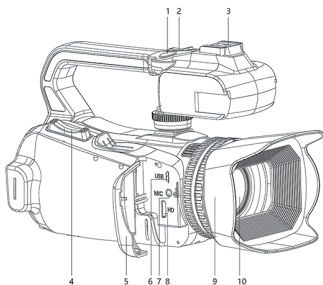

- 1: Handle shooting video / take photo button
- 2: Handle digital zoom lever
- 3: Handle hot shoe seat
- 4: Camera digital zoom lever
- 5: protection cap
- 6: USB interface
- 7: MIC interface
- 8: HDMI interface
- 9: Lens hood
- 10: Camera lens

Name	Function
Camera hot shoe seat	Base for installing handle, microphone and fill light
LCD screen	Display screen
SD card slot	Card slot for inserting SD card
Playback	Play the captured video or photo
Mode	Mode menu
Menu	Set shooting menu and system menu
Power	Power on / off
	Turn on/off the fill light
Battery slot	Install the battery
Shoot video button	Shoot video start / end
Take photo button	Take photo
	Half press focus
	Pause when recording
DISP button	Turn off screen menu display
	Close the display screen
Confirm button / control dial	Confirm
	Up, down, left and right buttons
Charging indicator light	The red light is displayed when charging, and it will go out when fully charged
Working indicator light	The blue light is always on after power on
Handle shooting button	Shoot video start or end / take photo
Handle digital zoom lever	Digital zoom button
Handle hot shoe seat	Base for installing microphone and fill light
Camera digital zoom lever	Digital zoom button
USB interface	USB cable charging
	Connect the computer with USB cable
MIC interface	External microphone interface(3.5mm)
HDMI interface	TV HDMI cable interface



Remote Control

The remote control uses 2 AAA batteries . In the unobstructed environment, it can be remotely controlled for a distance of 20 meters. It can remotely control the camera from a 360-degree angle.



- 01:Power button
- 02:Up button / digital zoom in
- 03:Right button
- 04:OK button
- 05:Shoot video button
- 06:Playback button
- 07:Mode button
- 08:Fill light button
- 09:Left button
- 10:Down button / digital zoom out
- 11:Take photo button
- 12:Menu button

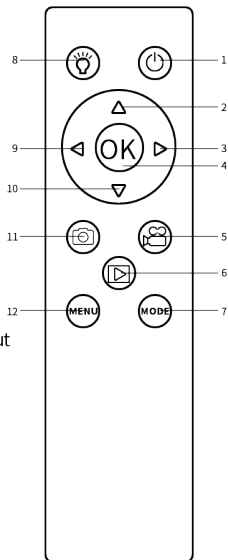

Touch screen operation

The camera has a touch screen function, which can be set by clicking the menu corresponding to the screen with your finger.

Click the center area of the screen to switch on / off the screen menu.

Using the menu button

Press the menu button to display the menu screen. You can change settings related to the camera as a whole, such as shooting and playback, and perform various functions.

Using the mode button

Select shooting mode

Press the mode button, and then press the control wave wheel button to select the corresponding mode

MODE	illustrate
Video	Normal recording mode
Slowly	Slow motion shooting
Loop	recording infinite loop
Lapse	Fast action shooting
Photo	Take a single photo normally
Auto	Automatically cycle take photos after a specified number of seconds
Burst	Take a specified number of photos in succession
Timer	Take a single photo after a specified number of seconds
PlayBack	Play the video or photo

Shooting function of this camera

Shooting menu settings

After selecting the corresponding mode, press the menu button to enter the shooting mode setting menu



Sub-menu	Menu content
Video Resolution	4K 60FPS/30FPS 2.7K 30FPS 1080P 60FPS/30FPS 720P 120FPS/60FPS/ 30FPS
White Balance	Auto/Sunny/Cloudy/Incandescent/Fluorescence
Exposure Setting	-3/-2/-1/0/1/2/3
Metering Mode	Average Metering/Center Metering/Spot Metering/Matrix Metering
Sharpness	High/Middle/Low
Video Quality	High/Middle/Low
ISO	Auto/100/200/400/800/1600/3200/6400
Time Watermark	Turn On/Turn Off (Press OK to switch)
Record Audio	Turn On/Turn Off (Press OK to switch)

Sub-menu	Menu content
White Balance	Auto/Sunny/Cloudy/Incandescent/Fluorescence
Pixellnset	64M/56M/48M/30M/24M/20M/12M/8M/5M/3M
Exposure Setting	-3/-2/-1/0/1/2/3
Metering Mode	Average Metering/Center Metering/Spot Metering/Matrix Metering
Sharpness	High/Middle/Low
Long Exposure	Auto/2S/5S/10S/15S/20S/30S
ISO	Auto/100/200/400/800/1600/3200/6400
Time Watermark	Turn On/Turn Off (Press OK to switch)

Slowly mode / Lapse mode

It is used to record the moment that cannot be captured by the naked eye (slow motion shooting), or shorten the long-time phenomenon to a short time for recording (fast motion shooting). It can record intense sports scenes, the moment when birds take off, the appearance of flower buds and the change of clouds and stars. The sound is not recorded.

Press the mode button, select Slowly mode / Lapse mode , and press the video button to start shooting. To finish shooting, press the video button again.

Video pause

This camera supports video pause. During the recording, press the Photo button, the recording is stopped and press the Photo button again, the recording is continued. If pressing the Record button again, the recording will end.

Tips: The recorded long video will be saved in the memory card in sections, and the document name is ***00000—***0000X.

Auto focus

In the photographing mode, the photo button has two layers. Gently press the first layer to focus, then press the second layer to take a picture. Gently press the first layer of the photo button, and the focusing logo frame will appear on the display until the camera has focused clearly. Then press the second layer of the photo button to take the best clear picture (normal focusing range >0.33ft).

In video mode, the photo button also has two layers. Gently press the first layer to focus, then press the second layer to pause / continue.

When the distance between the camera and the object is more than 0.33ft, gently press the first layer of the photo button, and the focus logo frame will appear on the display until the camera has focused clearly. Then press the record button to capture the best clear video (the focus range is > 0.33ft);

Mic interface

The camera supports an external microphone with a 3.5mm connector. Please note that this connector does not support headphone access.



Fill light

Short press the power button, the camera can turn on /off the fill light.

Note: Turning on the fill light will accelerate the loss of battery power. Lighting distance 1.5 meters.

Playback mode

Press the playback button to enter the playback mode. You can browse videos and photos by controlling the dial wheel.

To delete the corresponding video or photo, press the menu button and select Delete.

Note: after deletion, it cannot be restored. Please operate with caution.
Press the mode button to exit the playback mode.

Change camera settings

Memory card formatting

To ensure the stable operation of the memory card, it is recommended that you format the memory card with this camera when you use it for the first time. Note that formatting will delete all data recorded on the memory card. The data cannot be recovered. Be sure to back up any important data on your computer or other storage location.

For the SD card inserted for the first time, the camera will automatically pop up the Format dialog box and select the format operation. Or enter the system menu for setting, and press the menu button ⇒ mode button ⇒ down button ⇒ then find the format submenu.

Auto shutdown setting

You can set the time from when there is no operation to the automatic shutdown mode to prevent battery consumption.

Enter the system menu to set, press the MENU button ⇒ MODE button ⇒ DOWN button ⇒ then find the Auto shutdown submenu, select the corresponding time (off/3 minutes/5 minutes/10 minutes).

Reset

Reset the camera to its default settings. Even if you perform [Factory Reset].

Note: Please do not unplug the battery during the factory reset.

Operations with smartphones and computers

Use of WiFi

☉ Smartphone download app and WiFi connection

First, please scan the following QR code with your smartphone to download the app, or directly search XDV pro in Google Play and App store.

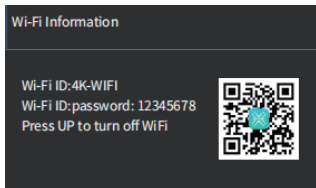

(1) Turn on the camera first, enter the menu of system setup, find the submenu of wireless hotspot, and press the OK key to turn on WiFi. The camera screen will show WiFi name or password.



(2) On your phone or tablet, turn on settings -----WLAN, find the WiFi name of the camera and enter WiFi password to connect the phone and the camera.

(3) Turn off the WIFI function: In the WIFI connection state, press the UP button to cut off the WIFI signal source of the camera, and the camera returns to the normal state.

(4) Enter the downloaded APP (XDV PRO), turn on the GPS function at the same time, click to select the WiFi with the same name as the WiFi displayed on the camera screen, you can enter the APP page, and control the camera to take pictures, video or menu settings through it.

Note: this WiFi is a wireless signal connected to the camera APP, it cannot directly connect to the Internet.

Use app to connect camera for shooting

After connecting, enter the app and click shoot, and then you can see the picture as shown in the figure. You can choose to take videos or photos.

Click the setting icon in the upper right corner to change the settings related to the camera as a whole, such as shooting, and perform various functions.

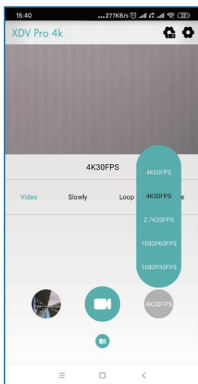

① Transfer videos or photos to smartphones and share to social software

Step 1: First, you need to enter the "XDV PRO" page of the "Media Gallery" in the APP, click the icon in the upper right corner, select a photo or video, and download it. If you can view the downloaded photos or videos in the album of the mobile phone or tablet where you downloaded the APP, then you don't need to go to "Step 2". You can share the photos or videos to social in the album. At this time you need to disconnect the camera's WiFi hotspot and connect to the mobile data traffic of your mobile phone or tablet).

Step 2: Disconnect the WiFi hotspot of the camera, connect the mobile data flow of the mobile phone or tablet, the APP interface will prompt "please restart the APP", select "OK" to automatically exit; then you need to enter the APP again, and the APP will prompt "Required turn on or off WLAN", select "Reject", click "2G/3G/4G network" immediately, click "OK" to enter offline mode; you can enter the "Phone" page of the "Media Gallery" in the APP, and then click the upper right corner icon, select photos or videos to share to social software (Note: it does not support two or more video files to be shared at the same time, nor does it support photos + videos to be shared at the same time).

Connect computer

Connect the camera to the available USB port on the computer with the USB cable. After inserting the USB cable, the camera will automatically turn on. Press the up and down keys to select the charging mode, storage mode or PC cam mode, then press the OK to enter.

Storage mode

When the storage mode is selected, a new removable storage device will be added in the "My Computer" window, which will transfer photos and video files to the computer.

PC cam mode

Select the PC cam mode, the camera can be used as a webcam, live streaming, etc.

Note: At this time, only the digital zoom lever can be operated on the camera, and other functions cannot be used.

Connect HD TV

The HD interface of this camera is only for connecting to a high-definition



TV, and cannot be connected to a computer. Please plug the public port of the HD cable into the HD interface of the camera, and connect the other end of the port to the HD input interface of the HD TV. Note that before connecting/unplugging the HD cable, please stop recording/playing the recording first. (The TV source needs to be adjusted to HD mode). The HD cable is suitable for the Mini HDMI to HDMI Cable.

Note: After connecting to the TV, the camera's display content will automatically switch to the TV, and the camera's screen will automatically go black. It is not a malfunction.

Charging mode

Select the charging mode, the functions of the camera can be used normally, the camera supports the function of recording while charging.

Usage notice

Safety Precautions

- (1) Do not disassemble or modify the product.
- (2) Please stop operating camera immediately if there are smoke or unpleasant smell on any parts of camera, otherwise it may cause fire or electric shock. Turn off camera immediately and remove camera's battery or unplug power cord from electrical outlet. Make sure the camera has stopped emitting smoke or unpleasant smell.
- (3) Do not expose or immerse the camera to water or other liquids. This camera is not waterproof. Please dry with a soft cloth if the case is exposed to liquid or salt water. Turn off camera immediately and remove camera's battery or unplug power cord from electrical outlet if water or other materials immerse into the camera.
- (4) Do not trigger the flash in close to human or animal eyes. Your eyesight may be damaged when facing a strong light source if the distance is too close. Please pay special attention to keep more than 1 meter (39 inches) away from baby.

- (5) Keep the camera and battery out of the reach of children.
- (6) Do not heat the battery or expose it to sources of ignition (otherwise it may explode).



Camera cleaning and maintenance

- (1) If you do not use the camera for a long time, take out the camera battery and place it in a dust-free, dry environment with a temperature no higher than 30 °C.
- (2) In order to extend the service life of the battery, please discharge it completely before storage.
- (3) Please fully discharge the battery at least once every 3 months after it has been fully charged.
- (4) If there is dust or dirt on the lens or screen, gently wipe it with a clean, soft lens cleaning cloth.
- (5) As this machine is a precision instrument, please do not drop it or suffer from strong impact or vibration.



Trouble removal

Trouble	Measures
Camera cannot start after battery is installed	The battery is low, please replace it with a new one.
	Battery pack not removed.
	The battery is not installed in place; please confirm that the battery is installed correctly.
Unable to charge	If the charging indicator light is flashing, the battery is not installed in place or in poor contact. Please reinstall the battery until the indicator light is on for a long time (the indicator light will go out when the battery is full).
	If the charging indicator is not on, the charger is not plugged in. Please check whether the charger is connected normally.
Remote control does not work	Check whether the remote control battery is dead.
	The remote control can't start the camera remotely. This is not a fault
HD cable connected TV cannot be connected	Check whether the TV source is set to HD mode.
	Check if the HD wire is connected correctly.
Unable to connect to PC	Please check whether the USB data cable is connected correctly.
	Please check whether the USB interface of computer is working properly.
	Please check the compatibility of the computer system.
Blurred shooting effect	The best distance for shooting is more than 10cm. Make sure the focus is clear and then press the shoot button
	Check whether the camera shake when shooting.